

Article number: 20511M625
Description: E+G Clamping kit
GN 511-M6-25

Measures

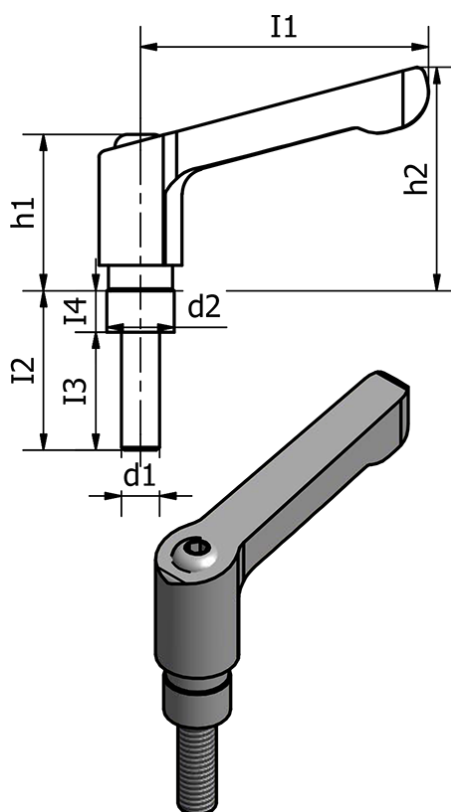

d1 = 6

d2 = 10.5

h1 = 24.5

h2 = 35

I1 = 45

I2 = 25

I3 = 18.5

I4 = 6.5

Weight (g) = 50